

FEATURES

- › INCLUDES SOLID ZINC DIE CAST MOUNTING PLATES: 2-3/16" x 1" [56 mm x 25 mm]; NYLON ANCHORS AND STEEL PHILLIPS HEAD SCREWS: #8 x 1-1/4" [32 mm]
- › ZINC DIE-CAST CONSTRUCTION (POSTS)

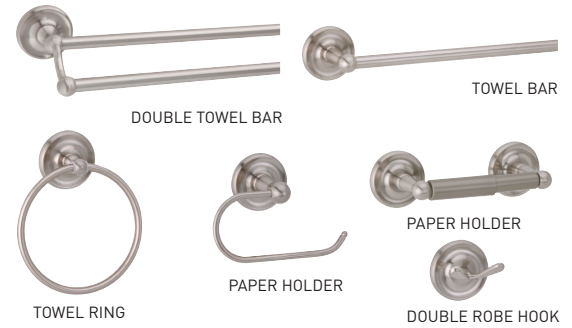

LIMITED LIFETIME WARRANTY



TOWEL BAR

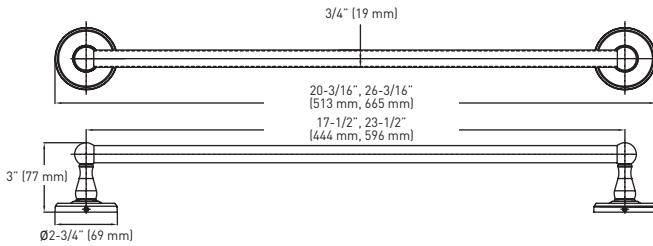

DOUBLE TOWEL BAR

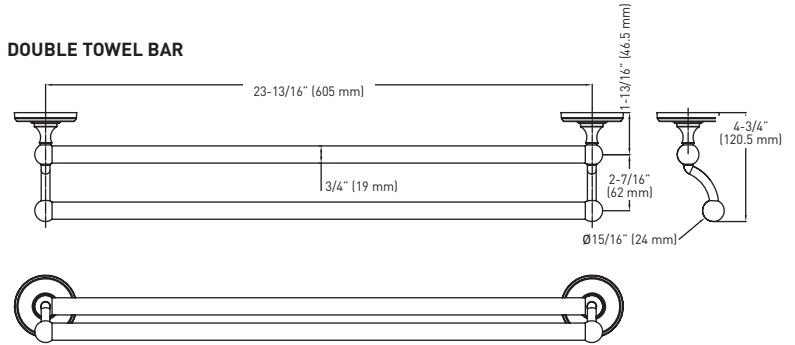

A - PAPER HOLDER

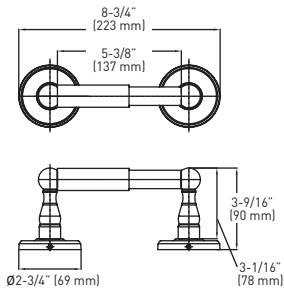

B - PAPER HOLDER

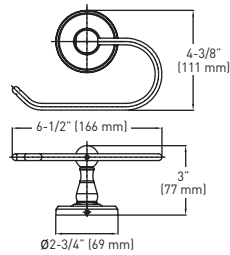

TOWEL RING

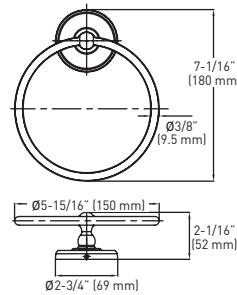

DOUBLE ROBE HOOK

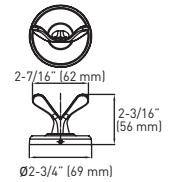

MEASUREMENTS SUBJECT TO A 3% VARIANCE

MEASUREMENTS ARE FOR REFERENCE ONLY. TAYMOR RESERVES THE RIGHT TO CHANGE THE PRODUCT SPECS WITHOUT NOTICE. FOR PRODUCT WARRANTY, PLEASE VISIT TAYMOR WEBSITE FOR DETAILS

RETAIL PACK	SATIN NICKEL 15	POLISHED CHROME 26	MATERIAL	CASE QTY.
TOWEL BAR - 18"	02-D6018SN	02-D6018	ZINC & ALUMINUM	4
TOWEL BAR - 24"	02-D6024SN	02-D6024	ZINC & ALUMINUM	4
DOUBLE TOWEL BAR - 24"	02-D6024DSN	02-D6024D	ZINC & ALUMINUM	4
DOUBLE ROBE HOOK	02-D6002SN	02-D6002	ZINC	4
A - PAPER HOLDER	02-D6008SN	02-D6008	ZINC & PLASTIC	4
B - PAPER HOLDER	02-D6048SN	02-D6048	ZINC	4
TOWEL RING	02-D6004SN	02-D6004	ZINC & ALUMINUM	4

