

PORTE-SAVON
HÔTEL/MOTEL
ACCESSOIRES DE BAIN COMMERCIAUX

Taymor



**FINITION
OFFERTE**

CHROME POLI
C26



CARACTÉRISTIQUES

- MONTAGE EN SURFACE EXPOSÉ
- COMPREND 2 VIS EN ACIER PHILLIPS
N° 8 DE 3,75 MM (1/4 PO)
- BOÎTIER EN LAITON MASSIF

PORTE-SAVON

HÔTEL/MOTEL

ACCESSOIRES DE BAIN COMMERCIAUX

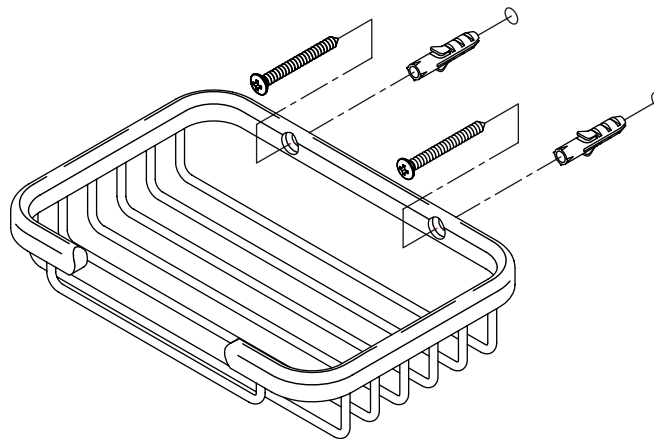
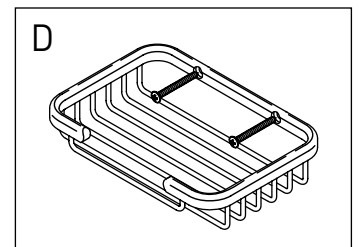
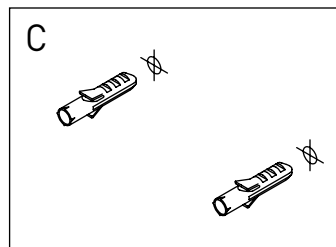
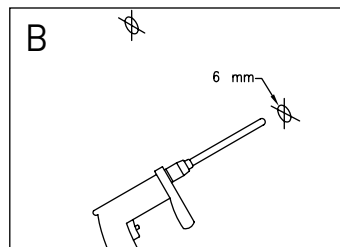
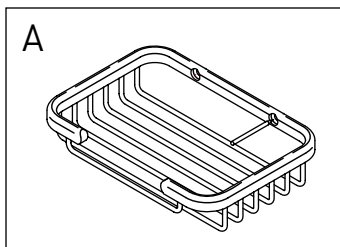
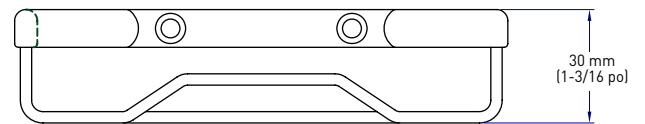
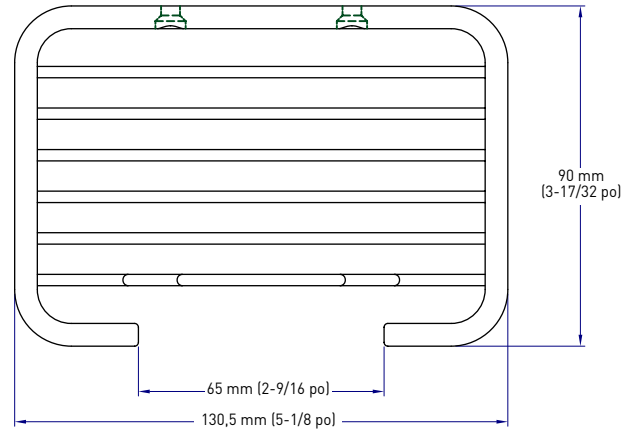

LES MESURES PEUVENT VARIER DE 3 %

PHOTO	DESCRIPTION	ACIER INOXYDABLE POLI C32D	QTÉ LA CAISE
	PORTE-SAVON	05-1083S	6